

Features

- 1 x 120W at 4ohms, for commercial and industrial use
- Lo-Z(8/4/2 ohms) / Hi-Z(70/100V) Compatible
- Bluetooth® / Front-panel input for portable player
- 4 inputs(2 Line, 2 Mic) and 1 output
- Priority Ducker and Feedback Suppressor for Mic.
- Priority muting with PTT switch
- Dynamic Loudness and Leveler for comfortable BGM
- Preset EQ and HPF for Loudspeakers
- Setup done locally from rear panel
- Expandable with optional power amplifier PCA1120
- 1U Rack mountable (with optional IRK-44-3)

SN 29403546A



Package Contents

- Main Unit
- AC Power Cord
- 5-pin Euroblocks (3)
- Instruction Manual (This Document)
- Safety Information
- Warranty Card

! This product is intended for commercial/professional use. It should be installed only by a specially-trained technician.

MCA1120 Rear Panel

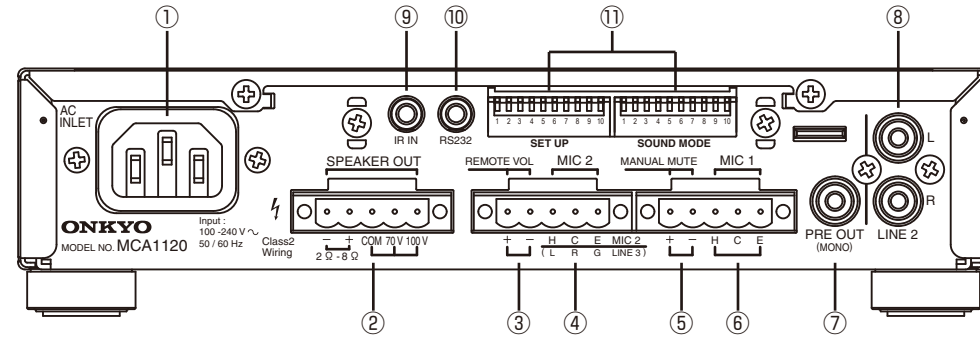

① AC Inlet (IEC C13, 100V-240V 50/60 Hz) (⇒ see Step 5)

② SPEAKER OUT Terminals (Euroblock)

NOTE

It is important to read "Step 2: Connecting Speakers" before attempting to use this terminal. IMPROPER SETUP CAN RESULT IN MALFUNCTION OR FIRE. (⇒ see Step 2)

③ Remote Volume Controller Terminal (Euroblock)

Use for connecting a commercially available volume controller. (⇒ see Option 2)

④ MIC 2 / LINE 3 Input Terminals (Euroblock)

Use for connecting either a Mic Level or Line Level device. (⇒ see Step 4)

⑤ Manual Mute Terminal for MIC 1 Input (Euroblock)

Use for connecting a Push-to-Talk switch for Priority Mute Paging. (⇒ see Step 4)

⑥ MIC 1 Input Terminals (Euroblock)

Use for connecting a wired microphone. (⇒ see Step 4)
For wireless microphone systems, use MIC 2 / LINE 3 terminal.

⑦ PRE OUT Terminal (RCA Mono)

This is a variable line output linked to the Master Volume. Use this output to link to expansion amplifier PCA1120 like in Example B. (⇒ see Option 1 for Setup)

⑧ LINE 2 Input Terminals (RCA Stereo)

Use to connect an external player such as CD, Music Streamer, etc. (⇒ see Step 3)

⑨ IR IN (3.5mm Mini, Mono / 2-pole)

For use with an external infrared controller.

⑩ RS232 (3.5mm Mini, Stereo / 3-Pole)

For use with an external controller, or for Custom EQ programming. **IMPORTANT:** To prevent damage, unplug the power cord when inserting/removing the RS232 cable.

⑪ DIP Switches

See Step 1 for instructions on how to set the DIP switches.

Step 1 : DIP Switch Settings

■ Step 1-A : [SET UP] Initial Setup Switches

IMPORTANT: Incorrect settings can damage your equipment. Set up carefully to ensure safe operation. **IMPORTANT:** DIP Switch setting changes will not apply until the unit is power cycled by removing the AC power cord for a while, and reinserting.

#1 [Keylock]

Locks the front panel controls with the exception of the Power button and Master Volume.

1	<input type="checkbox"/> Unlock
	<input type="checkbox"/> Lock

#2 [Auto Standby]

The MCA1120 automatically goes into the standby state after two hours when there is no audio signal and no operation.

2	<input type="checkbox"/> Off
	<input type="checkbox"/> On

NOTE : Auto Standby does not work when Bluetooth is connected.

#3, 4 [Auto Power On]

When an audio signal is detected on the selected input during Standby, the power is turned on automatically.

3	4	<input type="checkbox"/> Bluetooth / LINE 1
		<input type="checkbox"/> LINE 2
		<input type="checkbox"/> LINE 3
		<input type="checkbox"/> Off

#5 [Volume Control]

Select which type of optional external volume controller: Volume Control(10kΩ, B-curve type), or Infrared Remote System.

5	<input type="checkbox"/> Using a Volume Control (10kΩ) or <input type="checkbox"/> Unusing an External Control
	<input type="checkbox"/> IR control

#6 [MIC 2 / LINE 3]

Choose between MIC (Mono) or LINE (Stereo) input setting.

6	<input type="checkbox"/> MIC 2
	<input type="checkbox"/> LINE 3

#7 [MIC 2 AMP]

If switch #6 is set to MIC 2, select between On (Mic Level) or Off (Line Level).

7	<input type="checkbox"/> Off (Line Level)
	<input type="checkbox"/> On (Mic Level)

#8 [SPEAKER OUT]

Select Hi-Z or Lo-Z depending on your speaker specifications.

8	<input type="checkbox"/> Hi-Z (70V / 100V)
	<input type="checkbox"/> Lo-Z (2Ω / 4Ω)

! **NOTE:** It is important to read "Step 2: Connecting Speakers" before setting this switch. IMPROPER SETUP CAN RESULT IN MALFUNCTION OR FIRE. (⇒ see Step 2 for details)

#9 [Speaker Lo-Z]

If switch #8 is set to Lo-Z, you must adjust this switch according to your speaker specifications.

9	<input type="checkbox"/> Lo-Z : 4Ω minimum
	<input type="checkbox"/> Lo-Z : 2Ω minimum

! **NOTE:** It is important to read "Step 2: Connecting Speakers" before setting this switch. IMPROPER SETUP CAN RESULT IN MALFUNCTION OR FIRE. (⇒ see Step 2 for details)

#10 NOT USED

■ Step 1-B : [SOUND MODE] Sound Preferences Switches

Advanced configuration tools for Paging, EQ and DSP. **TIP:** These setting changes are instant. No power cycle is necessary.

#1 [Mic Ducker]

When the ducker senses audio from MIC 1 and/or MIC 2(not LINE 3), the volume of all other input sources will be attenuated by 24dB. This is useful for paging over background music.

1	<input type="checkbox"/> Off
	<input type="checkbox"/> On

If you set #6 [MIC 2 / LINE 3] of SET UP DIP switch to [MIC 2], you can use this function with two microphones.

#2 [Auto Leveler]

Automatically adjusts the level of each input signal for consistent volume across sources.

2	<input type="checkbox"/> Off
	<input type="checkbox"/> On

#3-5 [HPF (High Pass Filter)]

Use this filter to limit bass frequencies to the SPEAKER OUT terminals. The DIP switches set the cutoff frequency.

3	4	5	<input type="checkbox"/> <input type="checkbox"/> 50 Hz
			<input type="checkbox"/> <input type="checkbox"/> 40 Hz
			<input type="checkbox"/> <input type="checkbox"/> 60 Hz
			<input type="checkbox"/> <input type="checkbox"/> 70 Hz
			<input type="checkbox"/> <input type="checkbox"/> 90 Hz
			<input type="checkbox"/> <input type="checkbox"/> 150 Hz
			<input type="checkbox"/> <input type="checkbox"/> 200 Hz
			<input type="checkbox"/> <input type="checkbox"/> Off (No filter or using [Preset EQ for Loudspeaker])

NOTE : Do not set to [Off] when using Hi-Z speaker or the amplifier may go into protection mode.

#6, 7 [BGM Mode]

Select a Sound Mode based on the intended "mood" of the listening environment.

6	7	<input type="checkbox"/> <input type="checkbox"/> Natural : A Balanced Sound for most spaces
		<input type="checkbox"/> <input type="checkbox"/> Calm : A Relaxed, Laid-Back sound. Great for a Cafe, etc.
		<input type="checkbox"/> <input type="checkbox"/> Lively : An Upbeat sound. Great for a Gym, or Club
		<input type="checkbox"/> <input type="checkbox"/> Off : Flat Frequency response

#8-10 [Preset EQ for Loudspeaker]

Select the EQ preset for your speaker type(see list below).

8	9	10	<input type="checkbox"/> <input type="checkbox"/> Off
			<input type="checkbox"/> <input type="checkbox"/> Type 1 : Reserved for Onkyo
			<input type="checkbox"/> <input type="checkbox"/> Type 2 : Reserved for Onkyo
			<input type="checkbox"/> <input type="checkbox"/> Type 3 : Reserved for Onkyo
			<input type="checkbox"/> <input type="checkbox"/> Type 4 : Reserved for Onkyo
			<input type="checkbox"/> <input type="checkbox"/> Type 5 : B16
			<input type="checkbox"/> <input type="checkbox"/> Type 6 : B40
			<input type="checkbox"/> <input type="checkbox"/> Type 7 : J24CT

Step 2 : Connecting Speakers

! **Pay close attention to speaker setting / connection!** It may cause malfunction or fire.

- Connect AC power cord in final step. Do not connect AC power cord before this step. It may cause electric shock.
- Check the connection pins of Euroblock and Lo-Z / Hi-Z settings of DIP switches according to speaker specifications.
- **If these are not matched, it may cause malfunction or fire.**

■ Hi-Z (High Impedance) Connections

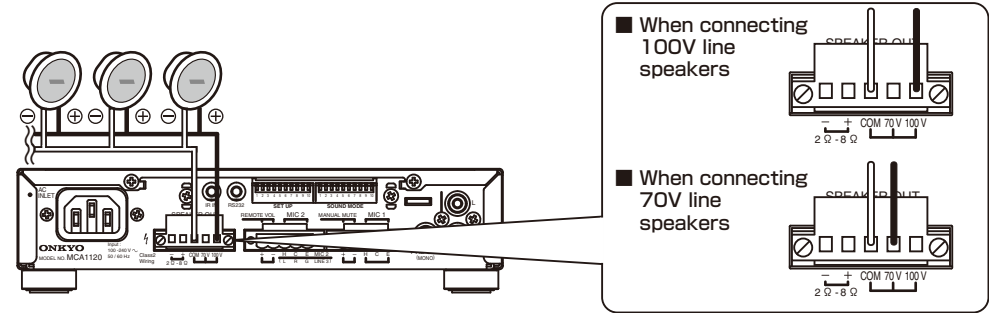

1. Set #8 [SET UP] DIP switch [SPEAKER OUT] to [Hi-Z].
2. Connect the [100V] or [70V] terminal of SPEAKER OUT to the + terminal on your speakers. Next, connect the [COM] to the - terminal on your speakers.

- Do not use the high impedance 70V line and 100V line terminals at the same time.
- Make sure that the total rated input power of the connected speakers is 120W or less.

■ Lo-Z (Low Impedance) Connections

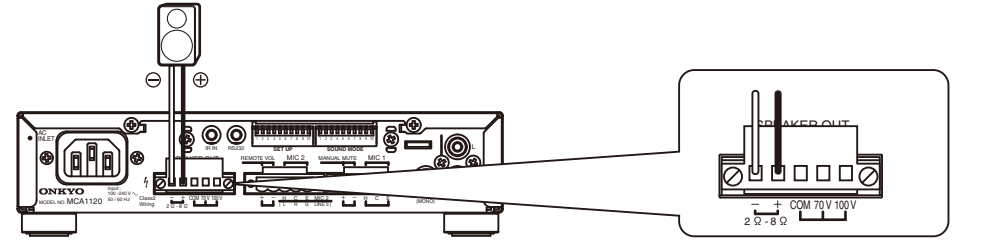

1. Set #8 [SET UP] DIP Switch [SPEAKER OUT] to [Lo-Z].
2. Connect the + terminal of SPEAKER OUT to the + terminal on your speakers. Next, connect the - to the - terminal on your speakers.

- Do not connect the Lo-Z speakers to the Hi-Z terminals.
- When connecting multiple speakers, make sure that the total impedance is more than the value of setting #9 [Speaker Lo-Z] of SET UP DIP switch.

Step 3 : Connecting External Players

Stereo signals are internally mixed into mono.

■ LINE 1 Connection

- See the "front panel" section on the back.

■ LINE 2 Connection

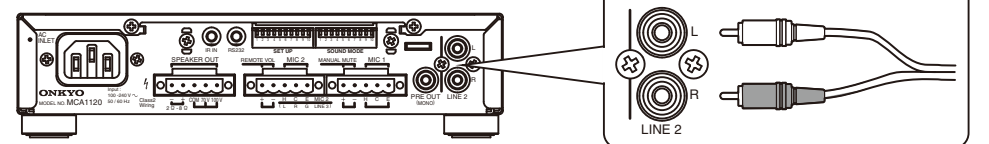

- Connect the external player to the LINE 2 terminals with the RCA cable. You can use either L or R terminal for the output of monaural player.

■ LINE 3 Connection

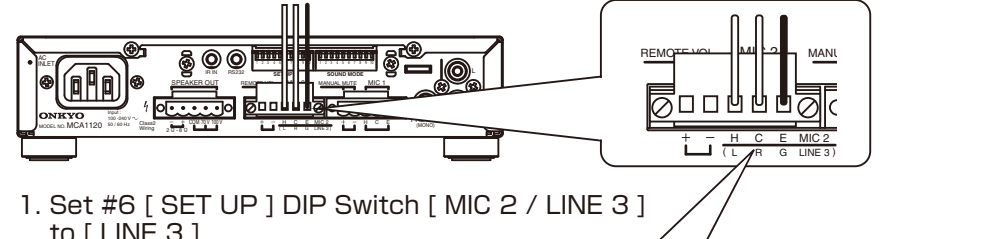

1. Set #6 [SET UP] DIP Switch [MIC 2 / LINE 3] to [LINE 3].

If this setting is missing, the in-phase signal (melody, bass line, etc.) will not come out.

2. Connect the output of the external player to the LINE 3 terminal with Euroblock.

You can use either L or R terminal for the output of monaural player.

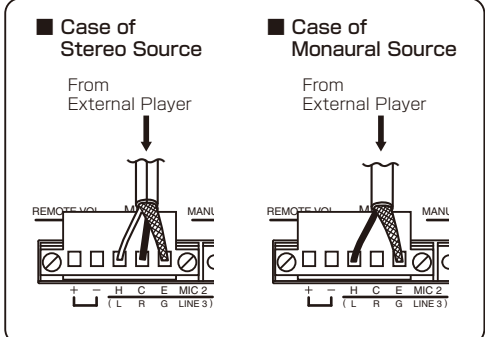

Setup and Operation Steps

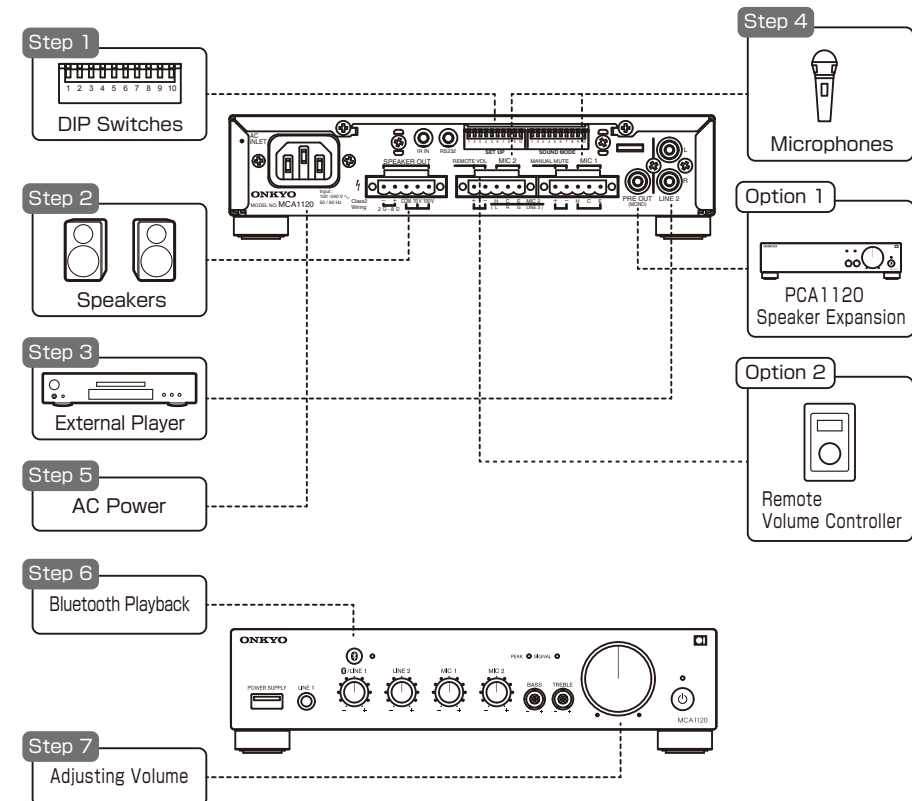

Step 4 : Connecting Microphones

- Mic Ducker and Feedback Suppressor can be used with either MIC 1/2.
- Connect the microphone with paging function to MIC 1, and wireless microphone to MIC 2.
- Since there is no phantom power, use battery-powered condenser microphone.
- Normal dynamic microphone can be used with either MIC 1/2 Input.

MIC 1 Connection

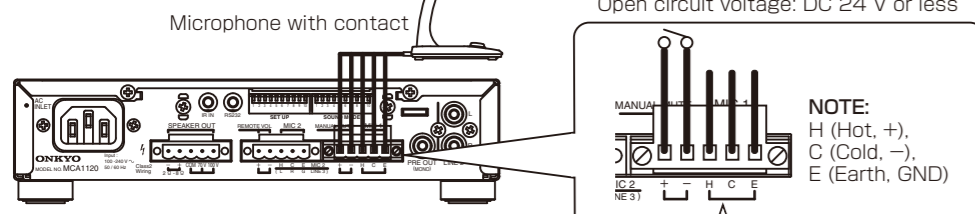

1. Connect the output of the microphone to the MIC 1 terminal with Euroblock.

2. If necessary, connect the PTT (Push-To-Talk) switch for paging to the MANUAL MUTE [+]/[-] terminals

You can mute the input sound other than MIC 1 while pressing the PTT switch. (Paging Function)

MIC 2 Connection

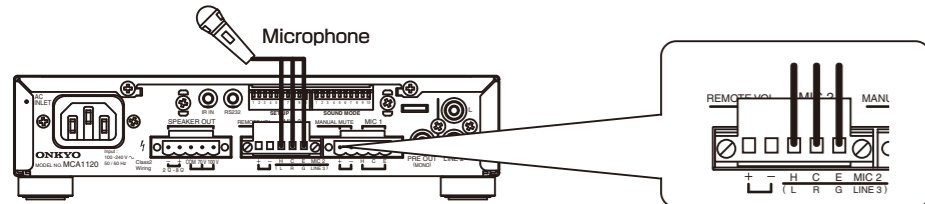

1. Set #6 [SET UP] DIP Switch [MIC 2 / LINE 3] to [MIC 2].

2. Use #7 [SET UP] DIP Switch [MIC2 AMP] to select between [On] (Mic level) or [Off] (Line Level).
If using a wireless MIC, this selection should be based off of the output level of the microphone receiver unit.

3. Connect the output of the microphone to the MIC 2 terminal with Euroblock.
For the connection method of the shielded wire, refer to the section on MIC 1 Connection.

Step 5 : Connecting Power Cord

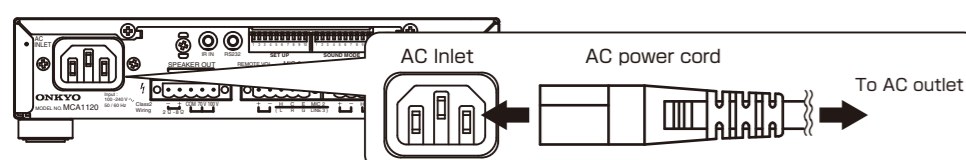

• Connect the supplied AC power cord to the AC Inlet and plug to AC outlet.

Specification

Speaker Output	Lo-Z (2Ω)	Lo-Z (4-8Ω)	Hi-Z (70, 100V)	Measurement Condition	
Rated Power	120W × 1ch	120W × 1ch(4Ω) 80W × 1ch(6Ω) 60W × 1ch(8Ω)	120W × 1ch	1kHz	
THD+N	≤0.5%	≤0.5%	≤1.0%	1kHz @ Full Rated Power	
Frequency Response	20 Hz - 20 kHz(+0dB, -6dB)			Reference 0dB @ 3W, 1kHz	
Signal-to-Noise Ratio	≤-90dB			LINE 2 input volume Max., other input volume Min., with IEC-C filter	
Input	LINE 1	LINE 2	LINE 3 *1	MIC 1	MIC 2 *1
Input Terminal	Stereo Mini (3.5mm) Unbalanced	Stereo RCA Unbalanced	EuroBlock Unbalanced	EuroBlock Balanced	EuroBlock Balanced
Exclusive Input	Bluetooth	---	MIC 2 *1	---	LINE 3 *1
Input Sensitivity	-14dBV	-10dBV	-10dBV	-50dBV	-50dBV
Input Impedance	43kΩ	14kΩ	14kΩ	2kΩ	2kΩ
Output	Lo-Z (2Ω)	Lo-Z (4-8Ω)	Hi-Z (70V)	Hi-Z (100V)	PRE OUT
Output Terminal	Euroblock Balanced (-/+)		Euroblock Balanced (COM / 70 or 100V)	Monaural RCA Unbalanced	
Max. Output Voltage	15.5Vrms	22Vrms	70Vrms	100Vrms	1Vrms
Rated Load	2Ω	4-8Ω	41Ω	82Ω	2kΩ

*1 : MIC 2 and LINE 3 are exclusive inputs. Only one can be used.

Bluetooth & USB	
Communication System	Version 5.0
Communication Range	Max. 10m (Line of sight approx.)
USB Power Supply	5V/2.1A (Not For Audio Playback)
General	
Operating Temperature	0 - 40 °C @ Non-condensing
Power Supply	AC100 - 240V(50/60 Hz)
Power Consumption	215W @ Rated Power, 10W @ Idling
Dimensions	
	1 RU high (w/o Feet), half rack wide
	8.5 W x 2.2 H x 12.6 D [inch](w/o legs 1.75H)
	215 W x 55 H x 319 D [mm](w/o legs 44.5H)
Product Weight	
	3.6kg(7.9lbs)
Option	
	Power Amplifier : PCA1120
	Rack Mount Kit : IRK-44-3

Specifications and features are subject to change without notice.

Option 1 : Expanding Speakers with PCA1120

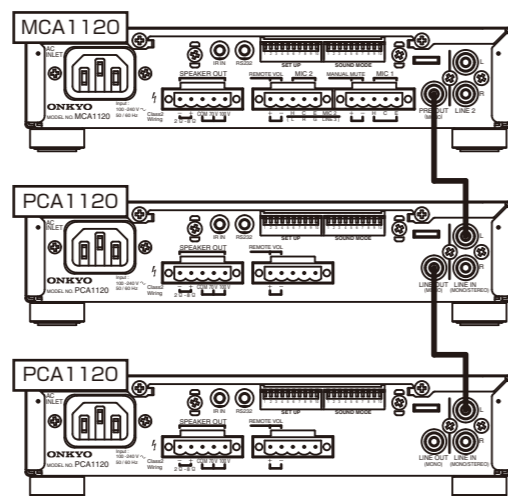

1. Connect the PRE OUT terminal of the MCA1120 and the LINE IN terminal (L or R) of PCA1120 with the monaural RCA cable.
2. Follow the instruction manual of the PCA1120, set the DIP switch and connect the speaker.
3. For further expansion, connect to another PCA1120 in series from the LINE OUT terminal of the PCA1120.

Benefits of combining MCA1120 with one or more PCA1120(s).

- a. Additional speaker zones can be added (See Example B).
- b. A passive subwoofer can be added to the system (See Example C).
- c. Both the MCA1120 and PCA1120 include independent Preset EQ and HPF, allowing you to tailor the sound of each speaker area.
- d. The MCA1120 Master Volume control can be used to adjust overall system volume for all areas since its PRE OUT terminal is variable. In this application, set the PCA1120 volume control to the center position (12 o'clock). Alternatively, you can adjust each PCA1120 volume independently.

Option 2 : Remote Volume Control

• Remote volume control by 10kΩ potentiometer. Remote volume and master volume function in series. If either is at minimum, there will be no sound.

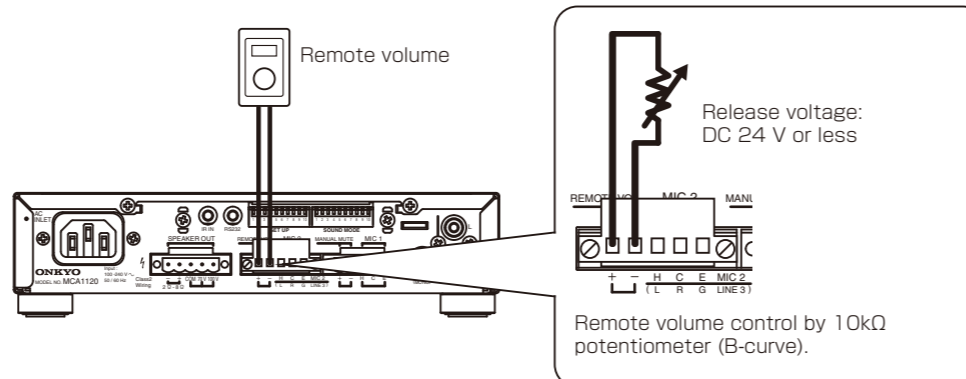

1. Set to [Volume Control(10kΩ)] of #5 [Volume Control] of SET UP DIP switch.
2. Connect the external volume(10kΩ, B-curve) to the Remote Volume Controller terminal with Euroblock.

Installing your amplifier

Do not block any ventilation openings. By playing your equipment at higher level for a long period, the protection circuit maybe activated by high temperature and the sound may drop.

Rack Mount

1. Remove four feet from the bottom of the unit.

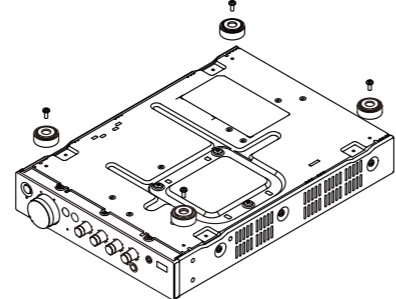

2. Attach the rack mount brackets IRK-44-3 by referring to the instruction manual.

3. Install the unit in your rack system.

Stacking Amplifiers

When stacking amplifiers without using a cabinet, keep enough space from the top surface of the unit. Do not remove feet for air ventilation.

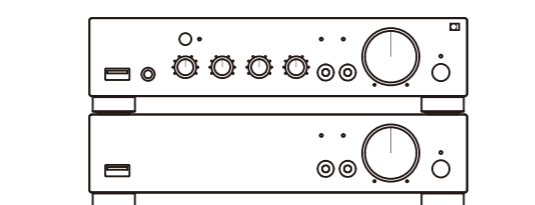

Since some parts such as cooling fans are consumable parts, it is necessary to replace the parts according to deterioration. For replacement, please contact the store you purchased or Onkyo service.

MCA1120 Front Panel

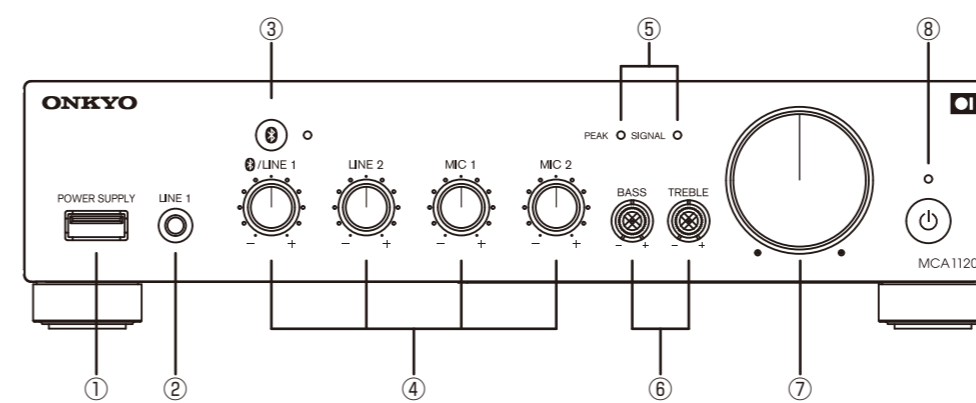

- 1 USB Power Supply Terminal (5V / 2.1A)
- 2 LINE 1 Input Terminals (3.5mm Mini, Stereo)
Connect a portable audio player, tablet, etc.
NOTE: When you connect a device into LINE 1 input during Bluetooth playback, Bluetooth audio stops and LINE 1 sound will be output.
- 3 [Ⓞ] Bluetooth Button / Indicator
Connect Bluetooth-enabled device such as portable audio player, tablet, etc. During pairing mode, the indicator blinks. When the indicator is lit, the device is connected.
NOTE: When you connect a device via Bluetooth while LINE 1 input is being used, LINE 1 input sound will stop and Bluetooth sound will be output.
- 4 Input Volume LINE 1(Bluetooth) / LINE 2 / MIC 1 / MIC 2 (LINE 3)
To Adjust each input level.
To adjust the level of LINE 3, use knob for MIC 2.
- 5 SIGNAL / PEAK Indicator SIGNAL Indicator
It lights up when the speaker output level becomes around -46 dB or more of the rated output.
It may not light up when the output level is low. It is not malfunction. Blinks when muted. (Muting function is done only by IR IN or RS232. This unit does not have this operation.) PEAK indicator
Lights up when the speaker output level reaches its peak (around -3 dB from the rated output).
If it lights continuously, the sound maybe distorted. Lower the volume if necessary.
- 6 BASS / TREBLE
You can adjust BASS (low frequency) and TREBLE (high frequency) from -10 dB to +10 dB. Use a small screwdriver, etc. .
- 7 Master Volume
Adjust the output level to the speaker and PRE OUT jack. Turning it to the right will increase the volume. If you add PCA1120, you can raise or lower the system volume by this knob.
- 8 [Ⓞ] Power Button / Indicator
Switch the Power Standby / On. The indicator lights up as follows.
Standby Red
On Green

Step 6 : Bluetooth® Operation

You can wirelessly play music on a Bluetooth-enabled device, such as a portable audio player, tablet, etc. USB POWER SUPPLY terminal supplies power to USB compatible devices.

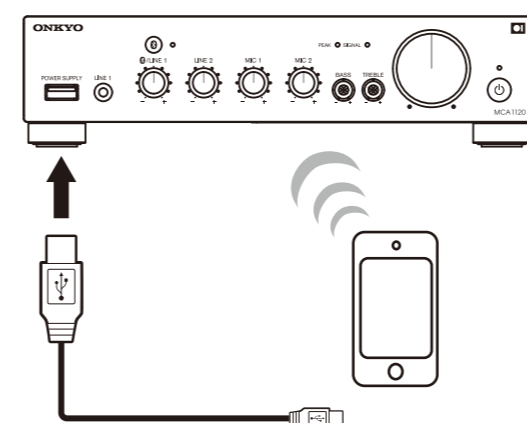

Pairing

1. While the power of this unit is on, press the Bluetooth button.
The indicator flashes and this unit is into pairing mode.
2. Enable (turn on) the Bluetooth function of the source device (tablet, etc.) , and then select "Onkyo MCA1120 XXXXXX".
If a password is requested, enter "0000".
When the pairing is completed, the indicator lights steadily.
To connect another Bluetooth device, repeat from step 1.
This unit can store maximum eight devices.

Playing Back

1. While the power of this unit is on, make a Bluetooth connection of a tablet, etc. and this unit.
2. Play music files.
3. Raise the volume of the tablet etc..
When you connect a device to LINE 1 input terminal during Bluetooth connection, the Bluetooth audio stops and LINE 1 sound will be output.

Step 7 : Adjusting Volume

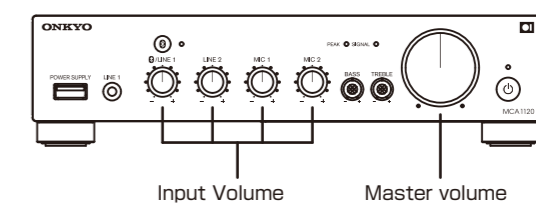

Adjust the total volume and mixing level of the external players and microphones.

1. Set the Input Volume to the position of the center (12 o'clock) connected to the external source device used by the main .
2. Keep the other input volumes to a minimum.
3. Play back the BGM and adjust the master volume to the optimum volume.
4. With the master volume decided in step 3 fixed, while outputting sound from other devices and microphones, gradually raise each input volume to balance the volume.
• If the volume is low even if the other input volume is maximized in step 4, lower the input volume in step 1 slightly and repeat from step 2.

Troubleshooting

Condition	Cause	Measures
Cannot turn on the unit	The power cord is not plugged.	Make sure that the power cord is properly plugged into the wall outlet.
	The protective circuit function is activated.	Unplug the power cord from the wall outlet. Check speaker wires, then plug it in again after a few minutes.
	Output music signal of connected player is very low.	Turn up the volume of player.
No sound	Volume level is not set correctly.	Set the master volume at center.
	Speaker setting is not correct.	Match the setting of impedance of Speakers. • Check total rated power of speakers is not overrated power of this unit.
	Bass/Treble setting is not correct.	Check settings of Bass/Treble.
No sound	[LINE 1] Volume level of external player is not correct.	Turn up the output volume level of the player. When the audio volume of your headphone output or Bluetooth device is set low, the playback of audio may be unavailable.
	[Particular input] INPUT VOLUME level is low.	• Adjust [Input Volume] level. • Adjust output level of connected player.
	No input signal.	Check the connection wire with external device. Check whether the external device outputs the signal or not.
No Sound	[LINE 3] Sound is loud or distorted.	Set the DIP switch to [LINE 3].
	#6 [MIC 2 / LINE 3] of SET UP DIP Switch is set to [MIC 2].	
No Sound	Using MIC level output microphone with MIC amp setting off.	Set #7 [MIC 2 AMP] of SET UP DIP Switch to [On].
Power indicator blinks and	Specification of speakers, settings of DIP switch and connected speaker terminal position are not matched.	Match impedance and connection of speaker and this unit. Check total rated power of speakers is not over rated power of this unit.
Volume is not up at certain level	Speaker cables are short-circuited.	Make sure bare speaker wires are not touching each other.
	The temperature of the unit rose abnormally.	Make sure the unit has plenty of space for ventilation around it. wait for the unit to cool down sufficiently, and then try turning it on again.
Cannot operate	Keylock is activated. Only power button and master volume work.	Set #1 [Keylock] of SET UP DIP Switch to [Unlock] position. Then unplug AC power plug. Then plug AC power plug after more than 20 seconds.
Bluetooth	Radio wave interference may occur in the vicinity of components, such as microwave ovens or cordless phones.	Place the unit far from microwave or cordless phones.
	Sound is interrupted by some applications.	Shut down the application which interrupt Bluetooth.
Operation is unstable	MicroPC function in this unit locked up.	Unplug and plug AC plug of this unit and connected Bluetooth equipment. If it did not work, connect to [LINE 1] with 3.5mm mini plug cord.
	---	The issue may be fixed by restarting this unit. During the power is on, press and hold power button for five or more seconds. Indicator blinks in red, then release the button.

More detailed information of "Troubleshooting" is posted on the Web. If symptoms do not improve even if referring to them, please contact Onkyo service.



1-10-5 Yokoami,Sumida-ku,Tokyo 130-0015 Japan
http://www.onkyoinstallation.com



<U.S.A.>
18 Park Way, Upper Saddle River, N.J. 07458, U.S.A.
Tel: 800-225-1946, 201-818-9200
Fax: 201-785-2650
http://www.onkyoinstallation.com

<Germany>
Gutenbergstrasse 3, 82178 Puchheim, Germany
Tel: +49-8142-4401-0 Fax: +49-8142-4208-213
https://www.eu.onkyo.com

<PRC>
302, Building 1, 20 North Chaling Rd., Xuhui District, Shanghai, China 200032.
Tel: +86-21-52131366 Fax: +86-21-52130396
http://www.cn.onkyo.com

Printed in Malaysia

©2018 Onkyo Marketing Corporation



The Bluetooth® word mark and logos are registered trademarks owned by Bluetooth SIG, Inc.